

Tricel® Puraflo 1-50

Installation

Wastewater Treatment Plants

Engineering a green future

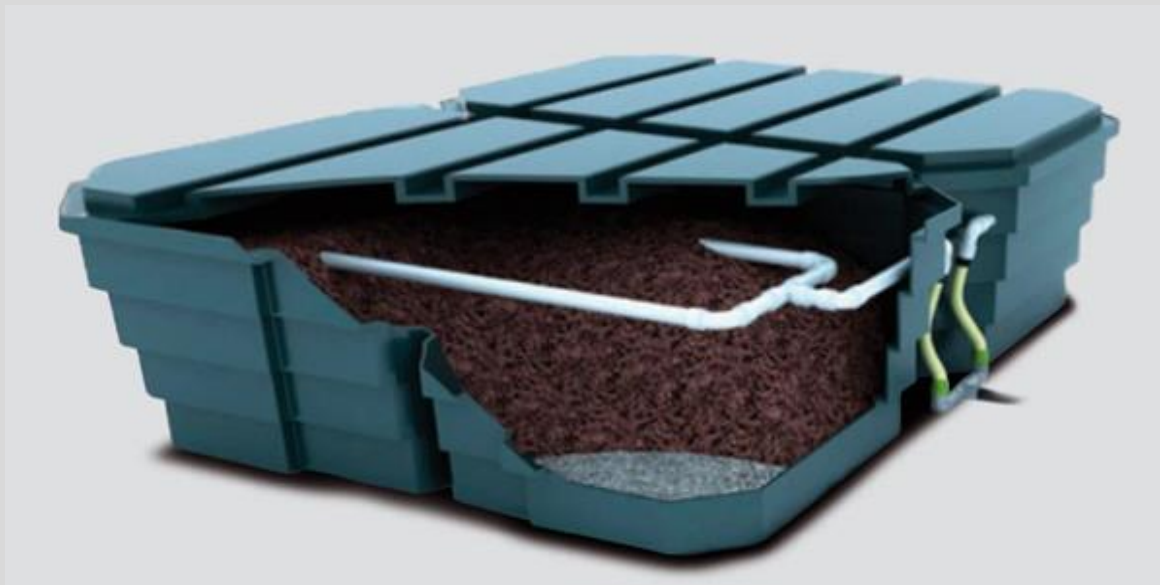

Contents

Contents	2
1 Health & Safety precautions	3
1.1 General	3
1.2 Electrical/maintenance	3
1.3 Installation:	4
2 Installation	5
2.1 Inspection on reception of Tricel Puraflo modules	5
2.2 Positioning and precautions	5
2.3 Tricel Puraflo systems: Max. Three Modules	6
2.3.1 Puraflo module installation – step by step guide	6
2.3.2 Septic tank effluent filter installation (Secondary Treatment only)	9
2.4 Tricel Puraflo systems: Over Three Modules	11
2.4.1 Indexing valve	11
2.4.2 Indexing valve – step by step installation procedure	12
2.5 Electrical requirements	14
2.5.1 Tricel Puraflo [gravity outlet] control panel wiring schematic	14
3 Commissioning	15
3.1.1 Secondary Puraflo Module Treatment	15
3.1.2 Tertiary Puraflo Module Treatment	15

1 Health & Safety precautions

This manual contains basic information on the installation, operation and maintenance of the Tricel Puraflo wastewater treatment system. For this reason, it is essential that these instructions are carefully read and understood before installation or commissioning by both the installation crew as well as those responsible for the operation and maintenance of the system.

This manual should be readily available at the location of the system. It is the responsibility of the homeowner to ensure that the wastewater treatment system is operated and maintained correctly and in a safe manner at all times. As safety and security are of vital importance, the following aspects are critical:

1.1 General

- Ensure that all the information contained in this manual is adhered to at all times.
- Treated wastewater is not suitable for human consumption. It is unhealthy for humans, pets, and wildlife to drink or come in contact with surface or ground water contaminated with sewage.
- It is important that locks are fitted to the lid to prevent accidental access.
- Never enter a tank, unless qualified to do so.
- Naked flames shall not be used in the vicinity of the tank due to the danger of combustion.
- The manhole covers shall never be left off an unattended tank. Always lock the covers of the plant when work is completed.
- Sewage and sewage effluent can carry micro-organisms and gases harmful to human health.
- Any person carrying out work on the wastewater treatment system must be appropriately trained.
- Suitable protective clothing; including waterproof/abrasion-resistant gloves, overalls, safety footwear, eye, ear and respiratory protection, goggles (face visors are particularly effective against splashes) should be worn at all times. All protective clothing must be in good condition and be fit for its intended purpose.
- Always remove contaminated clothing and protective equipment after working with wastewater treatment plants. Wash hands and face prior to eating, drinking or smoking.
- Wastewater treatment plants contain very low levels of oxygen. Hydrogen sulphide, methane, carbon dioxide and other life-threatening gases are also present. Tanks have manhole covers to provide access to the tank only in times of cleaning and inspecting the tank from outside. The manhole covers must always be in place and secure.
- Keep vehicles and other heavy equipment away from the wastewater treatment plant and percolation area.
- Erect a safety barrier around open manholes to prevent anyone from accidentally falling down the manholes.
- Keep children away from the septic system when it is being worked on.
- Do not smoke near wastewater treatment plants. Combustible gases could be present and cause an explosion.
- Contact a plumber or other qualified person if you smell 'sewer gases'. They can identify the source and correct it immediately.
- The sewage treatment process uses many beneficial microorganisms, like bacteria, in the treatment process. However, the plant also contains harmful bacteria, viruses and disease-organisms. Liquid and solid contents of the septic system are capable of causing infectious diseases.

1.2 Electrical/maintenance

- All electrical work to be carried out by competent persons using suitable materials for the application.

- Do not open the Tricel Puraflo alarm cover without firstly isolating the mains power. All power isolation switches should be turned off [Follow Lock-out/Tag-Out Procedure] before any maintenance/inspection work is done at the wastewater treatment plant.
- Never use electrical lights, appliances or power tools in or close to water or wet ground near the septic tank or percolation area. This can result in electrical shock or explosion.
- Electrical work must be carried out strictly to the manufacturer's instructions and to the relevant national rules for electrical installations. All connections to the control panel should only be made by competent qualified personnel. If a cable is damaged, it should be replaced immediately to prevent electrical shock or damage to the electrical equipment. All electrical connections are completed on site.
- When working with machinery/electrical equipment, proximity of water shall be noted. Electrical equipment shall not be wet when working with it.
- There is potential danger when de-sludging and therefore this shall never be done alone.
- A wastewater treatment system that fails to fully treat sewage due to poor maintenance or overloading may allow excess nutrients (phosphorus and nitrogen) to reach nearby lakes and streams, promoting algae and plant growth. Algal blooms and abundant weeds may make lakes unpleasant for swimming, boating, and other water-based activities. This plant growth can also affect water quality for fish and wildlife habitat. As plants die and settle to the bottom, they are broken down by bacteria that use up oxygen that fish need to survive.
- It is the responsibility of the owner to ensure that the wastewater treatment plant is operated and maintained correctly at all times.
- It is advised that the owner enters into a yearly Service Agreement to ensure the correct operation of their wastewater treatment plant.

1.3 Installation:

- Excavation work should be planned with due regard to health and safety requirements.
- Septic tank should also be properly vented in accordance with the tank manufacturer's guidelines.
- Excavated material should either be shored or battered back to a "safe" angle.
- Use appropriate lifting equipment.
- Care should be taken around ground work machinery.
- Keep proper footing and balance at all time.
- Tricel Puraflo modules are supplied with ropes for lifting purposes. The modules are designed for a single lift when placing them in position.

2 Installation

Important

Prior to the installation of the Tricel Puraflo system, it is important to carefully read these installation instructions.

2.1 Inspection on reception of Tricel Puraflo modules



- Tricel Puraflo modules should be visually inspected for damage which may have occurred during transport prior to installation. Any damage should be notified to the delivery driver and/or to your supplier. Do not attempt to carry out any unauthorised repairs, as this will invalidate the warranty on the modules.
- Once the modules have been installed, we cannot accept any claims for damage.



2.2 Positioning and precautions



- Only suitably qualified personnel should perform the installation of the Tricel Puraflo system.
- The groundwater level on the site must never rise above the base of the Tricel Puraflo modules.
- Suitably sized equipment will be required to excavate the hole and to lift the Tricel Puraflo system into place (minimum: 6-ton machine).
- The Tricel Puraflo system should not be installed in an area subject to flooding or excessive water runoff as no flood waters should enter the tank.
- When selecting the location of the Tricel Puraflo system, ensure that it is always accessible for future maintenance.
- A septic tank must be installed (or de-sludged if a retrofit installation) and empty, **but not in use**, during the installation of the Tricel Puraflo system. Tricel offer septic tanks with an effluent filter fitted if required.
- The location for each element of the system must be known and marked out prior to installation.
- In the case of tertiary treatment systems that discharge to a gravel base, the discharge area must be installed before the Tricel Puraflo system is installed. **Tricel is not responsible for the design and installation of the discharge area.**



2.3 Tricel Puraflo systems: Max. Three Modules

2.3.1 Puraflo module installation – step by step guide

Step		Description	
		Secondary Treatment	Tertiary Treatment
Site Preparation	1	The location for each element of the system must be known and marked out.	
Install Pre-module Treatment	2	Prepare excavation as per manufacturer's guidelines.	
	3	Install septic tank as per manufacturer's guidelines.	Install WWTP as per manufacturer's guidelines.
Install Effluent Filter	4	Install effluent filter at outlet of septic tank. For more information on the effluent filter, please see section 5.3.2.	
			
Install Pump Chamber (if required)	5	Prepare excavation as per manufacturer's guidelines.	
	6	Install pump chamber as per manufacturer's guidelines.	
Install Puraflo Modules	7	Excavate a hole that will allow for a minimum 250mm gravel base beneath the Puraflo modules. Taking note of water table and other site conditions. Puraflo modules can be installed above ground or so that the lids are level with the ground level, but the lids must never be covered .	Excavate a hole that will allow for a minimum 300mm gravel base beneath the Puraflo modules. Taking note of water table and other site conditions. Puraflo modules can be installed above ground or so that the lids are level with the ground level but the lids must never be covered .
		The gravel base must extend minimum 500mm beyond the footprint of the Puraflo modules on all sides.	The size of the area covered by the gravel base is determined by the Percolation values (PVs) obtained from the following table: Table 10.1 EPA Codes of Practice

Step	Description	
	Secondary Treatment	Tertiary Treatment
8	Lay a gravel base with 12-32mm washed gravel or broken stone to a height of 175mm. Ensure the gravel base is level.	Lay a gravel base with 12-32mm pea gravel to a height of 225mm. Ensure the gravel base is level..
9	Place the lentils on the gravel base perpendicular to the length of the modules. The 100mm side of the lentils must lie flat on the gravel base. Ensure that each lentil is level. The lentils must be spaced far enough apart that each module is supported at the locations outlined in the following image:	
		
10	Continue filling the excavation with gravel (10-20mm pea gravel) until the height of the gravel is level with the top of the lentils. The gravel must be levelled.	
		
11	A trench, for the rising main, must be dug from the pump chamber/water treatment plant to the Puraflo modules inlet assembly. We recommend a 300mm wide trench with a 650mm depth. The rising main must be surrounded by 150mm of gravel all around. The rising main pipe should be 500mm below ground level to prevent freezing. Backfill the rest of the trench with existing soil.	
12	Using the glue provided, the 32mm PVC outlet pipes must be attached to all modules before they are placed alongside each other as the pipework that feeds into the sample chamber(s) will be inaccessible when the modules are in place.	
		
13	Using the lifting ropes, lift the Puraflo modules into position, according to the layouts in Section 3.3, taking note of the left and right-hand alignments marked on the modules. Position the modules until they are just touching and they form a "V" where they meet at the outlet.	

Step	Description	
	Secondary Treatment	Tertiary Treatment
		
14	<p>The lifting ropes should be pulled down below the modules for better aesthetics.</p>	
15	<p>Create a hole 225mm deep in the gravel base where the sampling chamber will be located. Install the sampling chamber(s) so that the ledge fits under the Tricel PuraFlo modules and into the 'V' shape between the modules.</p> 	
16	<p>Install the remaining outer PVC pipes and connect them into sampling chamber. Once the pipework has been connected, build up the level of the pea-gravel directly beneath the pipework to provide support during the backfilling around the modules. This will prevent damage or sagging to the pipework which could result in blockages or leaks.</p> 	

Step	Description	
	Secondary Treatment	Tertiary Treatment
17	<p>Using the yellow inlet pipe assembly provided, connect the inlet pipework to each module. The rising main coming from the pump chamber/water treatment system should be connected to this inlet assembly in single zone systems (The rising main must be connected to the inlet of the indexing valve in multi-zone systems). The following images show the completed inlet assemblies of the 2 & 3 module systems:</p> <p style="text-align: center;"><i>Tricel Puraflo 2-module inlet assembly</i></p>  <p style="text-align: center;"><i>Tricel Puraflo 3-module inlet assembly</i></p> 	
18	<p>Once the rising main has been connected to the Puraflo modules, backfilling around the modules can be completed.</p>	
Note:	<p>The Tricel Puraflo modules must not be covered with soil. It is important that the outlet pipework is protected from sunlight and frost damage by ensuring that the Tricel Puraflo modules are backfilled with suitable material.</p>	



2.3.2 Septic tank effluent filter installation (Secondary Treatment only)

- Secondary Treatment Tricel Puraflo systems require an effluent filter to be installed at the outlet of the septic tank.
 - On sites in which complete secondary treatment systems i.e. where Septic Tank **AND** Tricel Puraflo modules are being installed, the effluent filter must be installed in the septic tank on

site by the installer unless the septic tank has been supplied with the effluent filter pre-installed, see section 5.3.2.1.

- On sites in which a Tricel Puraflo system will be installed with a pre-existing septic tank, an effluent filter must be installed at the outlet of the septic tank, if not already present.

2.3.2.1 Vento septic tank – effluent filter installation procedure

Step	Description	
1	Remove the filter bag and filter bag housing from the outlet of the Vento septic tank.	
2	Glue the 200mm length 110mm (4") diameter sewer pipe to the outlet of Vento septic tank.	
3	Fit the euro reducer into the effluent filter. Apply PVC sealant around the end of the 110mm pipe and push the effluent filter onto the pipe. Secure the effluent filter using a self-tapping screw in the location indicated by the arrow.	

2.3.2.2 3rd party septic tank - effluent filter installation procedure

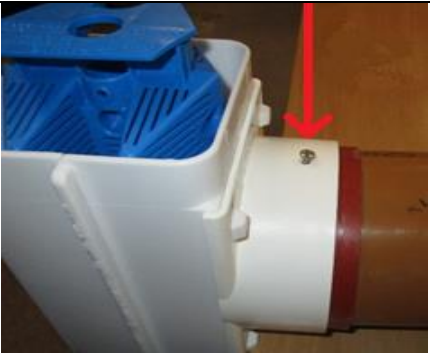
Step	Description	
1	Remove T-piece, if present.	
2	Fit the euro reducer into the effluent filter. Apply PVC sealant around the end of the 200mm 110mm pipe and push the effluent filter onto the pipe. Secure the effluent filter using a self-tapping screw in the location indicated by the arrow.	

Step	Description	
3	<p>To facilitate access to the effluent filter when installed in the tank. The 110mm (4") sewer pipe outlet may need to be extended inside the septic tank using straight coupler, as shown.</p> <p>Access to the effluent filter is required for maintenance and removal.</p>	

2.4 Tricel Puraflo systems: Over Three Modules



- Tricel Puraflo systems with four or more modules will consist of multiple zones. Each zone will consist of two or three modules.
- Wastewater is pumped to each zone intermittently via an indexing valve, which is positioned between the pump chamber and the Puraflo modules.





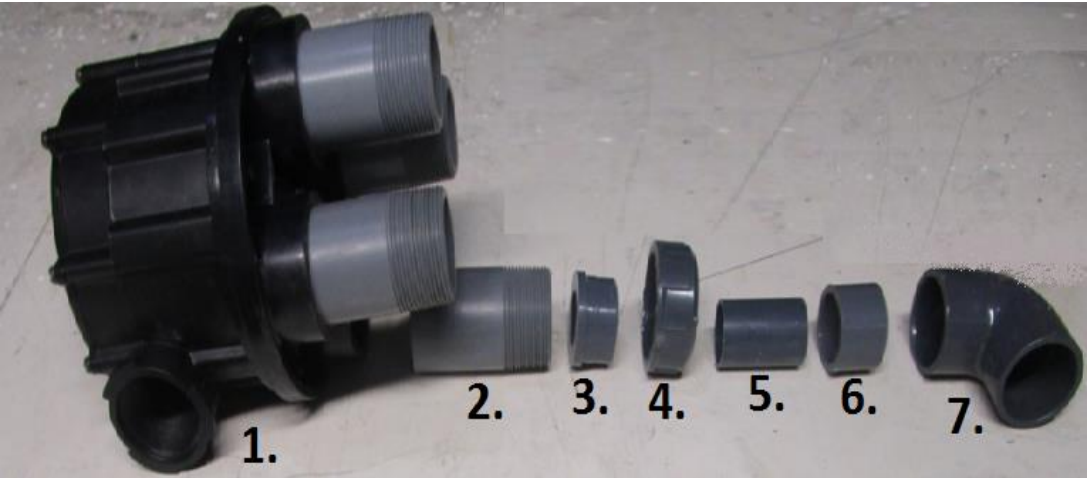

2.4.1 Indexing valve

- There are two types of indexing valve. The indexing valve supplied is determined by the number of zones in the Tricel Puraflo system.
 - 6-outlet indexing valve: Used in systems of 5 - 6 zones
 - 4-outlet indexing valve: Used in systems of 2 - 4 zones

2.4.2 Indexing valve – step by step installation procedure

Step	Description
1	<p>Apply PTFE tape to threads of Philmac fitting and thread into inlet of indexing valve.</p> 
2	<p>Assemble each of the active outlets required as shown below:</p> <ol style="list-style-type: none"> 1. Indexing valve 2. Threaded pipe (supplied with valve) 3. Union nut 4. Union end 5. 50mm length of 32mm pipe 6. 40-32mm reducing bush 7. 40mm elbow  <p>Note: The elbow (object 7. above) can be orientated to suit the installation.</p>
3	<p>Push hose tails into the flexible outlet pipework and secure with hose clips.</p> 

Step	Description	
4	Using a 50mm hole saw, drill the inlet hole and the required number of outlet holes. The inlet hole/outlet holes can be positioned at alternative locations around the bottom of the distribution box to suit the site conditions.	
5	Place the indexing valve into the distribution box, connect the outlet pipes (to Puraflo modules) and inlet pipe (from the pump chamber) to the indexing valve.	
6	Secure distribution box riser in place using six 25mm pan screws.	
7	Position the indexing valve as close to the Puraflo modules as site conditions allow.	

2.5 Electrical requirements

Important:

Please ensure the electrical installation complies with all national regulations and requirements.

The customers' minimum responsibility shall consist in the provision of:

- The power supply SWA cable(s) must be suitably sized and comply with all national regulations and requirements. The sizing of the cable is the responsibility of a qualified electrician.
- A qualified electrician is required make the final electrical connections to the control & alarm panel.
- The cable armour must be properly bonded to the main earth.

2.5.1 Tricel Puraflo [gravity outlet] control panel wiring schematic

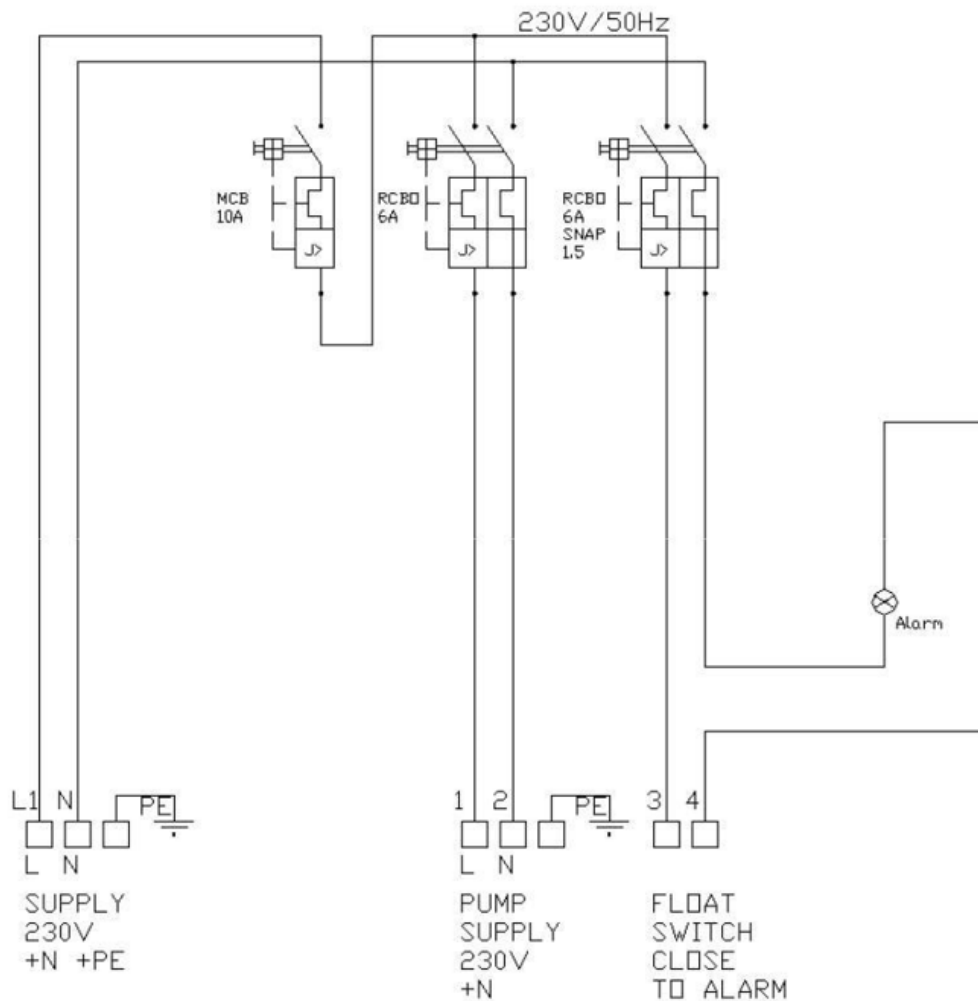

3 Commissioning

<u>Important</u>
The commissioning of a Tricel Puraflo system must only be done by a Tricel- approved service technician.

- It is important Tricel commission the Tricel Puraflo system to verify that the system has been installed correctly and ensure that the Tricel Puraflo will achieve the required treatment levels.
- The commissioning of the Tricel Puraflo system is done as part of the installation, when installed by Tricel.

3.1.1 Secondary Puraflo Module Treatment

Tricel Puraflo Modules		2	3	4	6	8	10	12	15
Max. Population Equivalent	PE	8	12	16	24	32	40	48	60
Design Flow Rate (max)	L/day	1200	1800	2400	3600	4800	6000	7200	9000
BOD Load (max)	Kg/day	0.48	0.72	0.96	1.44	1.92	2.40	2.88	3.6
No. of Persons		1-8	9-12	13-16	17-24	25-32	33-40	41-48	48 - 60
Overall Length	m	2.15	2.15	2.8	4.3	4.3	4.3	4.3	4.2
Overall Width	m	2.8	4.2	4.3	4.2	5.6	6.0	8.4	10.75
Overall Height	m	0.75	0.75	0.75	0.75	0.75	0.75	0.75	0.75
Weight *	Kg	600	900	1200	1800	2400	3000	3600	4500

3.1.2 Tertiary Puraflo Module Treatment

Tricel Puraflo Modules		2	3	4	6	8	10	12	15
Max. Population Equivalent	PE	8	12	16	24	32	40	48	60
Design Flow Rate (max)	L/day	1200	1800	2400	3600	4800	6000	7200	9000
BOD Load (max)	Kg/day	0.024	0.036	0.048	0.072	0.096	0.12	0.144	0.18
No. of Persons		1-8	9-12	13-16	17-24	25-32	33-40	41-48	48 - 60
Overall Length	m	2.15	2.15	2.8	4.3	4.3	4.3	4.3	4.2
Overall Width	m	2.8	4.2	4.3	4.2	5.6	6.0	8.4	10.75
Overall Height	m	0.75	0.75	0.75	0.75	0.75	0.75	0.75	0.75
Weight *	Kg	600	900	1200	1800	2400	3000	3600	4500

*Weight may vary due to moisture content in Coconut Fibre



Tricel (**Killarney**) Unlimited Company Trading as Tricel
Ballyspillane Ind. Est. Killarney, Co. Kerry, Ireland
Tel: +353 (0)64 663 2421 | Email: sales@tricel.ie | www.tricel.ie

Tricel Environmental UK, A trading brand of Dewey Waters Ltd.
Tricel Weston, Winterstoke Road, Weston-Super-Mare, BS24 9AN, United Kingdom
Tel: 44 (0) 1934 422 311 | Email: environment@tricel.co.uk | www.tricel.co.uk

In accordance with Tricel's normal policy of product development these specifications are subject to change without notice.