

# Tricel® Puraflo 1-50

## Wastewater Treatment Plants

*Engineering a green future*

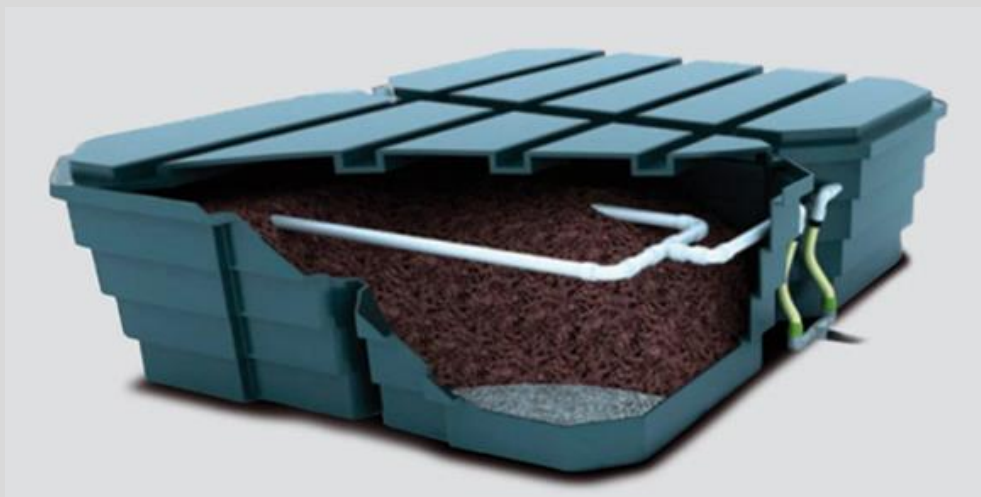

# Table Content

1.	Health & Safety Precautions.....	3
1.1.	General .....	3
1.2.	Electrical/Maintenance.....	4
1.3.	Installation: .....	4
2.	Introduction: Tricel Puraflo.....	5
2.1.	How a Tricel Puraflo Plant works: .....	6
2.2.	Tricel Puraflo: Typical Layout .....	7
2.2.1.	Plan view of Typical Tricel Puraflo Secondary System .....	7
2.2.2.	Plan view of Typical Tricel Puraflo Tertiary System .....	7
2.3.	Tricel Puraflo Applications.....	8
2.3.1.	Secondary Treatment .....	8
2.3.2.	Tertiary Treatment.....	8
3.	Tricel Puraflo Range .....	9
3.1.	System Specifications .....	9
3.1.1.	Secondary Puraflo Module Treatment.....	9
3.1.2.	Tertiary Puraflo Module Treatment.....	9
3.2.	System Components.....	10
3.2.1.	Tricel Puraflo Module .....	10
3.2.2.	Effluent Filter (secondary treatment only).....	10
3.2.3.	Pump .....	10
3.2.4.	Pipework.....	12
3.3.	System Layout Drawings:.....	12
4.	Transportation & Lifting .....	13
5.	Installation .....	13
6.	Commissioning .....	13
7.	Disposal of Treated Water .....	14
8.	Maintenance .....	14
8.1.	Regular Maintenance .....	14
8.1.1.	Septic Tank (If applicable) .....	14
8.1.2.	Wastewater Treatment Plant (If applicable) .....	14
8.1.3.	Effluent Filter (If applicable) .....	15
8.1.4.	Pump Chamber (If applicable) .....	15
8.1.5.	Control Panel .....	15
8.2.	Annual Service (Available from your supplier) .....	16

1.1.	De-sludging.....	16
9.	Operating Conditions.....	17
9.1.	Conditions:.....	17
10.	Troubleshooting.....	19
10.1.	Plant Operation.....	19
10.2.	Odours.....	20
11.	Certification.....	21
11.1.	Tricel Puraflo with Tricel Fortis.....	21
11.2.	Tricel Puraflo with Tricel Vento.....	23
11.3.	Tricel Puraflo.....	24

# 1. Health & Safety Precautions

This manual contains basic information on the installation, operation and maintenance of the Tricel Puraflo wastewater treatment system. For this reason, it is essential that these instructions are carefully read and understood before installation or commissioning by both the installation crew as well as those responsible for the operation and maintenance of the system. This manual should be readily available at the location of the system. It is the responsibility of the homeowner to ensure that the wastewater treatment system is operated and maintained correctly and in a safe manner at all times. As safety and security are of vital importance, the following aspects are critical:

## 1.1. General

- Ensure that all the information contained in this manual is adhered to at all times.
- Treated wastewater is not suitable for human consumption. It is unhealthy for humans, pets, and wildlife to drink or come in contact with surface or groundwater contaminated with sewage.
- Locks must be fitted to the lid to prevent accidental access.
- Never enter a tank, unless qualified to do so.
- Naked flames shall not be used in the vicinity of the tank due to the danger of combustion.
- The manhole covers shall never be left off an unattended tank. Always lock the covers of the plant when work is completed.
- Sewage and sewage effluent can carry micro-organisms and gases harmful to human health.
- Any person carrying out work on the wastewater treatment system must be appropriately trained.
- Suitable protective clothing; including waterproof/abrasion-resistant gloves, overalls, safety footwear, eye, ear and respiratory protection, goggles (face visors are particularly effective against splashes) should be worn at all times. All protective clothing must be in good condition and be fit for their intended purpose.
- Always remove contaminated clothing and protective equipment after working with wastewater treatment plants. Wash hands and face before eating, drinking or smoking.
- Wastewater treatment plants contain very low levels of oxygen. Hydrogen sulphide, methane, carbon dioxide and other life-threatening gases are also present. Tanks have manholes covers to provide access to the tank only in times of cleaning and inspecting the tank from outside. The manhole covers must always be in place and secure.
- Keep vehicles and other heavy equipment away from the wastewater treatment plant and percolation area.
- Erect a safety barrier around open manholes to prevent anyone from accidentally falling down the manholes.
- Keep children away from the septic system when it is being worked on.
- Do not smoke near wastewater treatment plants. Combustible gases could be present and cause an explosion.
- Contact a plumber or other qualified person if you smell 'sewer gases'. They can identify the source and correct it immediately.
- The sewage treatment process uses many beneficial microorganisms, like bacteria, in the treatment process. However, the plant also contains harmful bacteria, viruses and disease-organisms. Liquid and solid contents of the septic system are capable of causing infectious diseases.

## 1.2. Electrical/Maintenance

- All electrical work to be carried out by competent persons using suitable materials for the application.
- Do not open the Tricel Puraflo alarm cover without firstly isolating the mains power. All power isolation switches should be turned off [Follow Lock-out/Tag-Out Procedure] before any maintenance/inspection work is done at the wastewater treatment plant.
- Never use electrical lights, appliances or power tools in or close to water or wet ground near the septic tank or percolation area. This can result in electrical shock or explosion.
- Electrical work must be carried out strictly to the manufacturer's instructions and to the relevant national rules for electrical installations. All connections to the control panel should only be made by competent qualified personnel. If a cable is damaged, it should be replaced immediately to prevent electrical shock or damage to the electrical equipment. All electrical connections are completed on site.
- When working with machinery/electrical equipment, proximity of water shall be noted. Electrical equipment shall not be wet when working with it.
- There is potential danger when de-sludging and therefore this shall never be done alone.
- A wastewater treatment system that fails to fully treat sewage due to poor maintenance or overloading may allow excess nutrients (phosphorus and nitrogen) to reach nearby lakes and streams, promoting algae and plant growth. Algal blooms and abundant weeds may make lakes unpleasant for swimming, boating, and other water-based activities. This plant growth can also affect water quality for fish and wildlife habitat. As plants die and settle to the bottom, they are broken down by bacteria that use up oxygen that fish need to survive.
- It is the responsibility of the owner to ensure that the wastewater treatment plant is operated and maintained correctly at all times.
- It is advised that the owner enters into a yearly Service Agreement to ensure the correct operation of their wastewater treatment plant.

## 1.3. Installation:

- Excavation work should be planned with due regard to health and safety requirements.
- Septic tank should also be properly vented in accordance with the tank manufacturer's guidelines.
- Excavated material should either be shored or battered back to a "safe" angle.
- Use appropriate lifting equipment.
- Care should be taken around grounds work machinery.
- Keep proper footing and balance at all time.
- Tricel Puraflo modules are supplied with ropes for lifting purposes. The modules are designed for a single lift when placing them in position.

## 2. Introduction: Tricel Puraflo

Tricel Puraflo is a modular wastewater treatment system which can cater for large or small populations. It is a flexible system which can treat effluent from one-off domestic houses, small communities and light commercial applications through the implementation of additional Puraflo modules.

The Tricel Puraflo system uses Coconut fibre to break down the effluent making this type of treatment system popular, using little to no energy. The Tricel Puraflo system works in conjunction with your septic tank or wastewater treatment plant. The wastewater is distributed evenly over the top of the Coconut filter, using a specially designed pipe network, to ensure optimum performance. Through a combination of biological, chemical and physical processes the Coconut fibre treats the wastewater as it filters through. The Tricel Puraflo is designed such that maintenance requirements are minimised while at the same time effectively treating effluent.

The Tricel Puraflo can be implemented as secondary or tertiary treatment as part of a complete wastewater treatment system.

## 2.1. How a Tricel Puraflo Plant works:

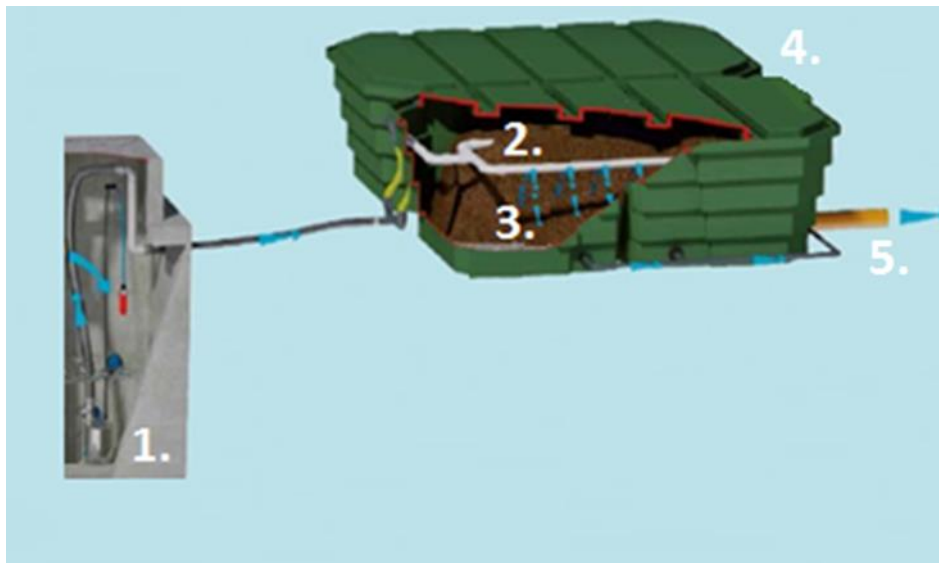

*Typical Tricel Puraflo System*

### **Stage 1**

Liquid effluent is pumped, by submersible pump, intermittently on- demand to the Puraflo modules.

### **Stage 2**

Effluent is distributed evenly onto the Coconut filter via a distribution grid at the top of each Puraflo module.

### **Stage 3**

Liquid effluent undergoes treatment as it filters through the Coconut fibre in the Puraflo modules.

### **Stage 4**

Highly treated effluent can be sampled at the in-built sample chamber.

### **Stage 5**

Treated wastewater flows from the outlet of the sampling chamber and is discharged to a percolation area/polishing filter.

## 2.2. Tricel Puraflo: Typical Layout

### 2.2.1. Plan view of Typical Tricel Puraflo Secondary System

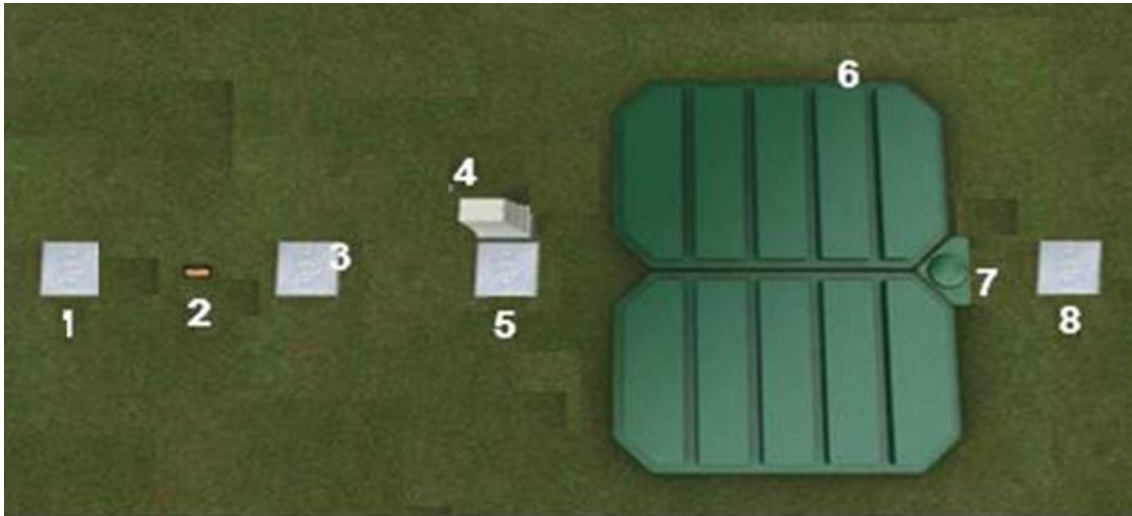

- 1 Manhole Cover – Inlet to Septic Tank (access to inlet tee)
  - 2 Septic Tank Vent Pipe with Cowl. Vents may vary depending on septic tank.
  - 3 Manhole Cover – Outlet from Septic Tank (access to filter) \*
  - 4 Tricel Puraflo Kiosk (contains control panel & alarm)
  - 5 Manhole Cover – Tricel Puraflo Pump Chamber
  - 6 Tricel Puraflo Modules – Number of modules depend on loadings
  - 7 Sampling Chamber
  - 8 Distribution Box – Flowing to percolation area/pump chamber to discharge treated liquid.
- \* Some septic tanks may only have one manhole cover.

### 2.2.2. Plan view of Typical Tricel Puraflo Tertiary System



- 1 Manhole Cover – Inlet to wastewater treatment plant (access to inlet tee)
  - 2 Manhole Cover – Outlet from wastewater treatment plant \*
  - 3 Tricel Puraflo Modules – Number of modules depend on loadings
  - 4 Sampling Chamber
  - 5 Distribution Box – Flowing to percolation area/pump chamber to discharge treated liquid.
- \* Some wastewater treatment systems may only have one manhole cover.



## 2.3. Tricel Puraflo Applications

Tricel Puraflo modules can be used in secondary and tertiary treatment applications. The appropriate treatment depends on the level of treatment required, the flow rates and the area available on site for the installation.

### 2.3.1. Secondary Treatment

- For secondary treatment, the Tricel Puraflo is used in conjunction with a septic tank.
- A Tricel Puraflo secondary treatment kit comprises of an effluent filter (must be fitted to the septic tank) a pumping chamber with control & alarm kiosk as well as the Puraflo modules with a sampling chamber

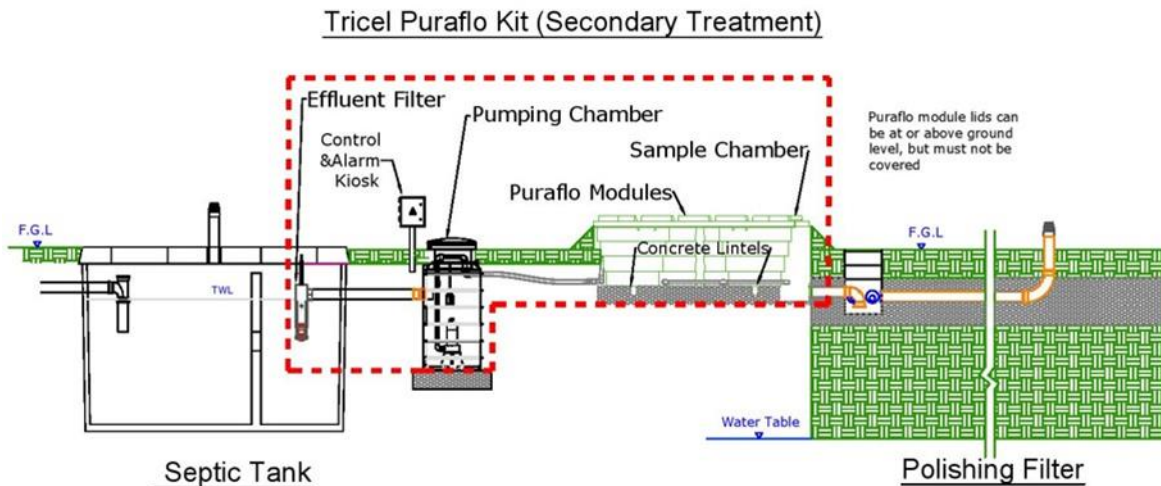

### 2.3.2. Tertiary Treatment

- Environmentally sensitive sites or sites that are restricted in terms of space, often require a higher level of treatment. This is achieved by passing the secondary treated wastewater through the Tricel Puraflo modules, within which the wastewater is treated to a higher treatment level this is known as tertiary treatment. Tertiary treatment will achieve very high-level pathogen and nutrient reduction.
- A Tricel Puraflo tertiary treatment kit consists of a pump with control and alarm kiosk, the Puraflo modules as well as a sampling chamber.

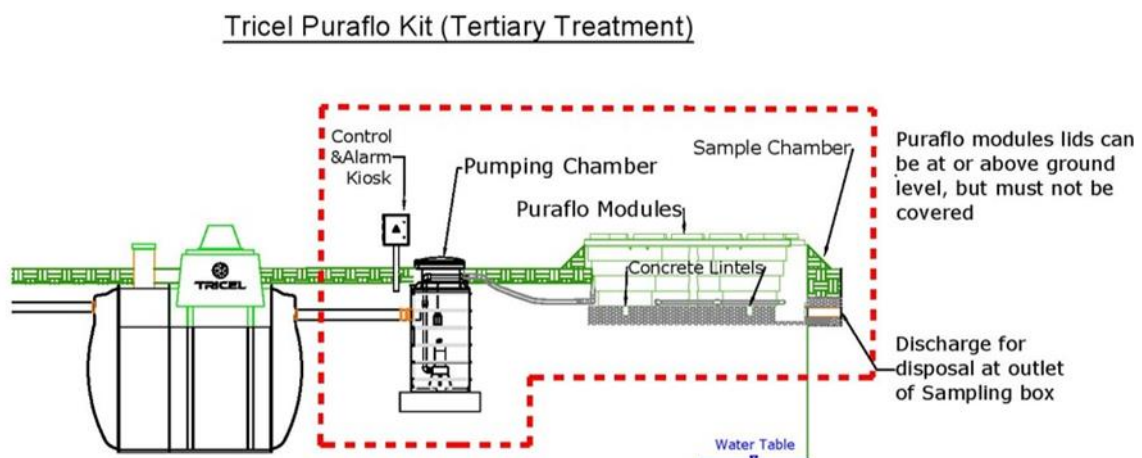

## 3. Tricel Puraflo Range

### 3.1. System Specifications

Tricel Puraflo is a flexible system for treating wastewater. Tricel Puraflo systems are implemented in zones and each zone contains multiple modules, as outlined in the table below.

In systems comprising of multiple zones, the wastewater is pumped to each zone sequentially ensuring equal dispersion and optimum treatment.

#### 3.1.1. Secondary Puraflo Module Treatment

Tricel Puraflo Modules		2	3	4	6	8	10	12	15
Max. Population Equivalent	PE	8	12	16	24	32	40	48	60
Design Flow Rate (max)	L/day	1200	1800	2400	3600	4800	6000	7200	9000
BOD Load (max)	Kg/day	0.48	0.72	0.96	1.44	1.92	2.40	2.88	3.6
No. of Persons		1-8	9-12	13-16	17-24	25-32	33-40	41-48	48 - 60
Overall Length	m	2.15	2.15	2.8	4.3	4.3	4.3	4.3	4.2
Overall Width	m	2.8	4.2	4.3	4.2	5.6	6.0	8.4	10.75
Overall Height	m	0.75	0.75	0.75	0.75	0.75	0.75	0.75	0.75
Weight *	Kg	600	900	1200	1800	2400	3000	3600	4500

#### 3.1.2. Tertiary Puraflo Module Treatment

Tricel Puraflo Modules		2	3	4	6	8	10	12	15
Max. Population Equivalent	PE	8	12	16	24	32	40	48	60
Design Flow Rate (max)	L/day	1200	1800	2400	3600	4800	6000	7200	9000
BOD Load (max)	Kg/day	0.024	0.036	0.048	0.072	0.096	0.12	0.144	0.18
No. of Persons		1-8	9-12	13-16	17-24	25-32	33-40	41-48	48 - 60
Overall Length	m	2.15	2.15	2.8	4.3	4.3	4.3	4.3	4.2
Overall Width	m	2.8	4.2	4.3	4.2	5.6	6.0	8.4	10.75
Overall Height	m	0.75	0.75	0.75	0.75	0.75	0.75	0.75	0.75
Weight *	Kg	600	900	1200	1800	2400	3000	3600	4500

\*Weight may vary due to moisture content in Coconut Fibre

## 3.2. System Components

### 3.2.1. Tricel Puraflo Module

Dimension	Unit	Value
A	mm	750
B	mm	1185
C	mm	1400
D	mm	1935
E	mm	2150
Height of Coconut fibre in Module	mm	600
Vol. of Coconut fibre in Module	M <sup>3</sup>	1.44

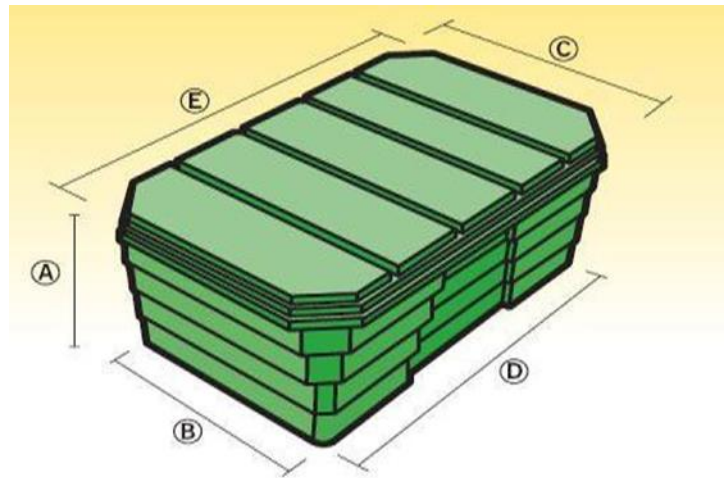

#### Warning

It is imperative that the treatment system is not overloaded hydraulically or organically. The number of modules that are required to treat the wastewater has been designed in accordance with the EPA CoP. If the owner feels that the modules are being overloaded, please contact Tricel, as it is possible to add modules to accommodate any extra loadings.

### 3.2.2. Effluent Filter (secondary treatment only)

- Secondary Treatment Tricel Puraflo systems require an effluent filter be installed at the outlet of the septic tank to retain solids in the septic tank so that the Tricel Puraflo modules are not overloaded.
- It is important the filter is cleaned regularly to ensure the correct operation of the system and reduce the chance for sewerage backing up. It is recommended that the effluent filter is cleaned bi-annually using a garden hose over the septic tank



### 3.2.3. Pump

- The submersible pump and float switch are fitted with a thermal overload protection.
- Effluent from the septic tank or waste water treatment is pumped via a 1.5inch (38mm) pipe to the Tricel Puraflo modules.

- The standard pump can cater for a total head of up to 5 metres. For systems that are subject to a total head greater than 5m, alternative pumps can be sourced. All pumps are single phase 220–240 volt 50-Hz motors with enclosures to IP 68.
- A high-level alarm is fitted and a visual warning light is located in the kiosk to alert the owner to pump malfunctions.
- If a pump chamber is required, the dimensions of the pump chamber are outlined in the following diagram:

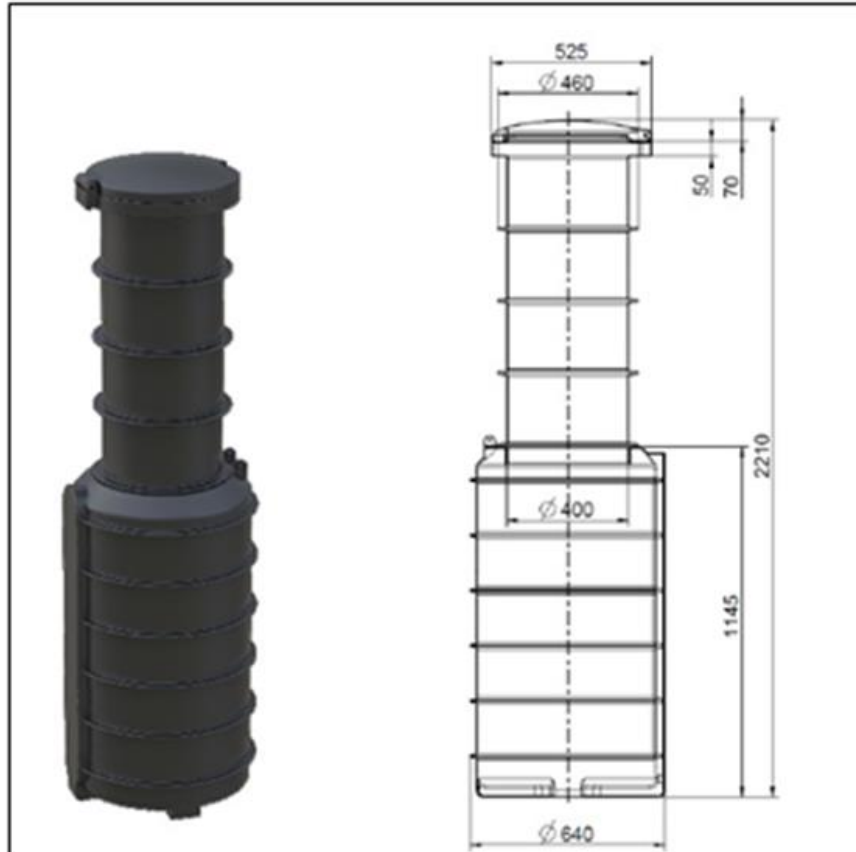

### 3.2.4. Pipework

The pipework supplied with the Tricel Puraflo modules to collect the treated wastewater from the Puraflo modules, and the pipework used for the dispersion of wastewater on top of the Coconut fibre inside the Puraflo modules, is in accordance with BS 3505: 1986\*

\*Specification for unplasticized polyvinyl chloride (PVC-U) pressure pipes for cold potable water.

### 3.3. System Layout Drawings:

Tricel Puraflo 2 Module System

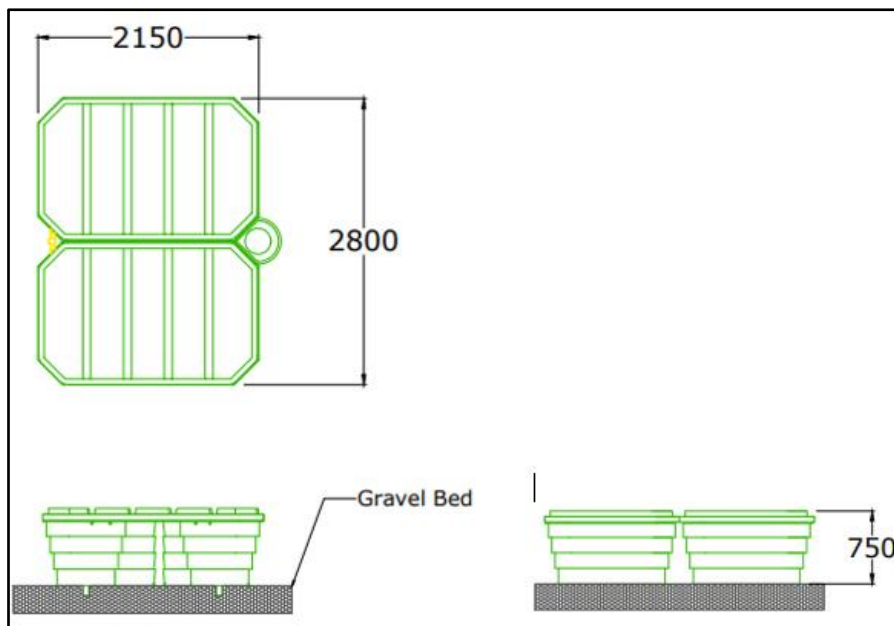

Tricel Puraflo 3 Module System

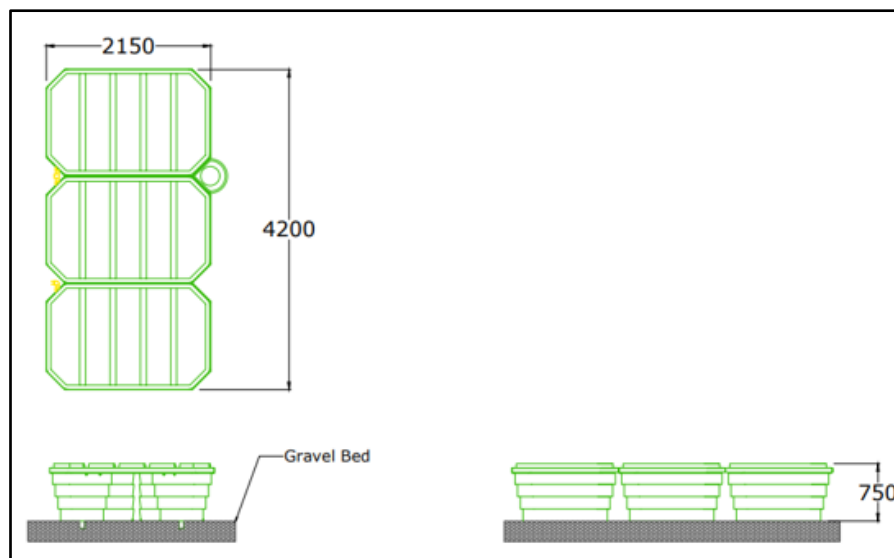

**Important**

If you required drawings for larger Tricel Puraflo systems, please visit <http://ie.tricel.eu/downloads/>.

## 4. Transportation & Lifting

- Tanks must be held down during transportation using nylon straps, do not use cables or chains to secure the modules.
- Do not over tighten straps that can result in deformation of the module shell.
- Do not drop or roll modules from the truck.
- Move modules only by lifting and setting, do not drag or roll.
- Always set the module(s) on flat smooth ground clear of debris etc.
- Modules are best lifted by a machine and webbing lifting straps – do not use chains or wire ropes in contact with the modules.
- Care is needed to control the lift to ensure the modules are not damaged.
- The modules are designed for a single lift when placing them in position. Always lift modules from above using the four lifting ropes attached to the tanks, as shown the following images



Figure 1 - Lifting Puraflo Module



Figure 2 - Setting Puraflo Module in position

## 5. Installation

**Important**

The installation of a Tricel Puraflo system must only be carried out by a Tricel-authorized distributor or a Tricel service technician.

## 6. Commissioning

**Important**

The commissioning of a Tricel Puraflo system must only be carried out by a Tricel-authorized distributor or a Tricel service technician.

## 7. Disposal of Treated Water

The treated wastewater from the Tricel Puraflo system should be disposed of as per guidelines from the planning regulations issued by your local authority.

## 8. Maintenance

### Warning

When working on the Tricel Puraflo system during routine maintenance & servicing, please follow all national health and safety regulations. Sewage and sewage effluent can carry micro-organisms and gases harmful to human health. Any person carrying out maintenance on the system must be appropriately trained. Suitable protection equipment including gloves, goggles etc., should be worn at all times. Always remove contaminated clothing and protective equipment after completion of work. Wash hands and face prior to eating, drinking or smoking. Refer to section.

The Tricel Puraflo system is designed with the best of quality and performance in mind to meet your specific wastewater treatment requirements and to provide years of trouble-free use. However, a certain amount of system maintenance is required on an on-going basis to ensure that the system is working correctly. **This is the responsibility of the homeowner.**

Failure to maintain your system could also result in reduced effectiveness and increased maintenance and/or replacement costs in the long-term.

### 8.1. Regular Maintenance

#### 8.1.1. Septic Tank (If applicable)

- The septic tank should be de-sludged when required. In accordance with EPA guidelines, the septic tank should be de-sludged a minimum of once a year. Consult the manufacturer's guidelines.
- De-sludging of the septic tank should prevent any solids carryover from the septic tank into the Tricel Puraflo modules which would decrease the performance of the treatment system.
- The inlet and outlet should be inspected and rodded to remove any blockages if necessary.
- Ensure that no storm or surface water enters the system.
- Ensure that the effluent filter is not blocked or matured (clogged naturally over time). Blockages will result in backups in the septic tank which will back-up towards the house if the problem is not resolved.

#### 8.1.2. Wastewater Treatment Plant (If applicable)

- The wastewater treatment plant should be inspected a minimum of once a year and be de-sludged when required. The sludge level should never be more than 50% of the depth of the liquid.
- The vent around the base of the blower housing guarantees a fresh supply of air to the air blower. All vents should be checked to make sure they are not blocked or obscured.
- The vent under the de-sludging cover allows gas to escape and stops the tank from becoming pressurised.
- Ensure the air blower is working by listening for a gentle hum when standing beside the plant.
- The inlet and outlet should be inspected and rodded to remove any blockages if necessary.
- Ensure that no storm or surface water enters the system.
- The wastewater treatment plant should be serviced once a year or as per the manufacturer's instructions.

### **8.1.3. Effluent Filter (If applicable)**

- The filter should be inspected and cleaned bi-annually.
- Do not use plumbing when cleaning filter.
- Pull the filter out of the housing when cleaning.
- Hose off the filter over the septic tank, ensuring that all solids fall back into the septic tank.
- Insert the filter cartridge back into the housing ensuring that the filter is properly aligned and inserted correctly.

### **8.1.4. Pump Chamber (If applicable)**

- The pump chamber should be inspected annually and the following checks and procedures should be followed.
- Remove the manhole cover and de-sludge tank if necessary.
- Turn up the high-level alarm float switch and check that the alarm light flashes in the control panel.
- Clean the high-level alarm float switch if necessary.
- Ensure that the high-level alarm float switch is positioned correctly to ensure correct operation.
- Check the position of the pump to ensure that the control float has free movement within the pump chamber.

### **8.1.5. Control Panel**

- Familiarise yourself with the location of the electrical control panel:
- Secondary treatment systems: The control panel is located inside the kiosk supplied.
- There is a red light located on the side of the kiosk to signal a fault has occurred in relation to the pump.
- In the event of an electrical storm or power failure, the circuit-breaker switches off the electrical lines feeding the pump. The pump/alarm should be checked to see if they tripped to the off position. If a circuit breaker switch is tripped, the power supply to the alarm/pump should be restored as soon as possible.
- Tertiary treatment systems:
  - The control panel is located in the wastewater treatment plant.

Respond to alarm conditions promptly



*Tricel Puraflo Control Panel*



## 8.2. Annual Service (Available from your supplier)

- The Tricel Puraflo system will require a full service (available from your supplier) once a year to guarantee the efficiency of the system is maintained. Service personnel must be accommodated with clear access to the system.
- During routine servicing, the following items are checked if applicable:

Checks	Procedures
The general condition of the pump chamber is good.	The vents in the sampling chamber are cleared.
The pipework inside the pump chamber is secure.	The electrical control panel and alarm system are tested.
The pipework in the sampling chamber is secure.	The pump and float switch are tested.
The lid of the sampling chamber is in good condition.	The distribution outlets in the modules are cleared of any blockages.
Condition of the media is inspected.	The level of the sludge in the septic tank/primary storage chamber is measured.
The system is inspected for any obvious non-wastewater infiltration into any compartment (at the time of inspection).	
The effluent filter in the septic tank is checked and cleared of any blockages if required (only applies to secondary system).	
General appearance and condition of the treatment system and the surrounding ground area is good.	
The distribution pipe network inside the modules are inspected	The perforation holes are cleared of any blockages. Shield caps are in place.
Condition of Coconut Fibre is inspected	Correct level of media present. Saturation level checked

### 1.1. De-sludging

To ensure that the Tricel Puraflo system performs effectively, the septic tank/wastewater treatment plant must receive regularly maintenance.

- The de-sludging must be performed by qualified personnel. De-sludging is done with a vacuum tanker (we recommend the use of a licensed company).
- Please remove all floating and settled sludge from the septic tank/ primary chamber of the wastewater treatment plant during de-sludging.
- During the de-sludging, the effluent filter at the outlet of the septic tank should be removed from its housing and hosed down to remove any materials which may result in blockage (secondary treatment only).

## 9. Operating Conditions

### Warning

Before installing/operating the Tricel Puraflo system, please read this manual in its entirety, paying special attention to the section entitled 'Health and Safety Precautions'. Normal health and safety precautions should be adhered to at all times, as well as the appropriate procedures to avoid the occurrence of accidents.

The manufacturer's installation, operation and maintenance instructions outlined in this manual must be followed at all times to ensure the system operates as designed. Any variations to these guidelines could result in the unit not performing to its full potential and the discharge may not meet the required standards. The property owner has a legal responsibility to ensure that the system does not cause pollution, a health hazard or nuisance.

### 9.1. Conditions:

- De-sludging is a critical part of the successful operation of the Tricel Puraflo system and is the responsibility of the customer. Only competent and approved personnel should carry out de-sludging. De-sludging must be carried out when required as specified, and the system should be inspected regularly to check the depth of sludge in the primary chamber. If de-sludging is required it should be done as soon as possible.
- An electrical connection to the plant must be maintained for it to function correctly. This ensures that the plant has a continuous air supply and where necessary the discharge pump will operate.
- The Tricel Puraflo system is one part of the overall wastewater treatment system, which includes many components (plumbing, ventilation, plant and polishing filter). Each component has to function correctly for the overall system to work which is the responsibility of the homeowner
- If the plant is not installed correctly, flooding, overloading, electrical shock or floatation may occur. We are not responsible for incorrectly installed plants.
- Soakaways, drains and the emptying of primary chamber remains the responsibility of the client. Damage to the installation due to the influx of surface water or the backing up of soak ways or drains is not covered by the manufacturer.
- To ensure the continuance of the Tricel Puraflo system's performance the user has to take certain precautions including the following:
  - The design loading of the system should not be exceeded
  - High volume discharges, such as those from swimming pools and Jacuzzis must never enter the system.
  - Surface water must not enter the system.
  - Do not allow large quantities of chemicals to enter the system, including but not limited to:
    - Detergent
    - Water softener
    - Disinfectants
    - Strong acids and alkalis, or photographic chemicals
    - Oil or Grease
    - Petrol or Diesel
    - Pesticides
  - Acceptable in normal conditions and usage. Excess amounts of biological detergent can affect the biomass development. If you have to use an unusual amount, it may be a good idea to spread it over a few days.
  - In applications that produce large volumes of grease (e.g. commercial kitchens) it is advised that a suitably sized grease trap is installed and maintained effectively to ensure the correct

operation of the Tricel Puraflo system. Fats or grease present in the system will greatly reduce the operating efficiency of the system and will greatly reduce the life expectancy of the Coconut fibre.

- Generally speaking, all common household cleaning fluids are acceptable, provided they are used in accordance with the maker's instructions and stipulated concentrations.
- Do not allow any of the following to enter the Tricel Puraflo system:
  - Large quantities of milk, alcohol or food
  - Large quantities of bleaches or cleaners
  - Baby wipes, cosmetic and cleaning wipes
  - Sanitary towels
  - Tampons
  - Kitchen paper
  - Nappies
  - Medication
- Service personnel must be accommodated with clear access to the system.
- If others size the system, we will supply to these specifications. In this case, the responsibility lies with others in relation to the maximum flow/litres per day, the system capacity and retention times. Similarly, if we size the system and a greater load is placed on the system by the addition of extra houses, bedrooms, schools, crèche's etc., or by other means, we are not responsible for the system in terms of overloading or quality of effluent as the retention times may be compromised.
- The modules are not suitable for vehicular traffic. We also recommend fencing off the area to prevent livestock herds from accessing the system.
- There must be no load placed on the lids of the Puraflo modules and the lids must not be covered.
- There must be no vegetation planted in the ground adjacent to the Puraflo modules.
- In the event that a non-Tricel approved installer is installing the system, please ensure that the installer has the required skills and knowledge to ensure that the system is installed correctly.

# 10. Troubleshooting

## 10.1. Plant Operation

Symptom	Possible causes	Solution
Pump Won't start or run	Fuse blown (if applicable)	Replace with fuse of suitable size
	Tripped Breaker	Reset Breaker
	Low Line voltage and wet electrics	An electrician should check the power supply to the plant
Pump operates but delivers no water	Low Line voltage or wired incorrectly	An electrician should check the power to the plant
	Something caught in impellers	Clean out impellers or replace pump <b>WARNING: Ensure pump is disconnected from the main before you attempt to unclog it.</b>
	Delivery hose blocked	Find blockage and remove or replace damaged hose
	Other pump malfunction	Pump must be checked by a qualified person.
Plant fills above working water level	Float from the pump is stuck	Ensure the float on the pump is set correctly and can move freely
	Storm water flooding	Redirect storm water drains. Storm water must never enter the plant.
	Discharge hose/pipe blocked	Find blockage and remove or replace damaged hose/pipe.
	Pump not working	Check pump is function properly as above
Pump runs intermittently	Thermal overload tripped.	Check for clogged impeller. <b>WARNING: Ensure pump is disconnected from the mains before you attempt to unclog it.</b>
	Damaged float	The pump has run dry so add water. Pump must be checked by a qualified person.
Alarm is lighting but the pump and is working	High level float is snagged or caught on the side of the tank.	Free the high-level alarm float; unsnag it from the side of the tank.
	Electrical fault	Get a qualified person to check that the alarm is installed correctly
	The electrical panel is wet	Get a qualified person to check that the alarm is installed correctly.
Build-up of grease and fat particularly on the float switches and pumps.	Build-up of grease and fat may happen over a long or short period of time depending on type of material entering the tank.	The float and pump may need to be withdrawn for hosing down. Once the pump and float have been cleaned, they will operate in a more efficient manner.

## 10.2. Odours

When the Tricel Puraflo system is correctly installed and operated there should be no strong odour in the area adjacent to the system. The presence of a strong odour would indicate that the plant is not working effectively.

Note:

Before taking any corrective action, always positively identify the real source of the odour. Check if the odour is coming from another outside source such as a storm drain. All wastewater treatment plants vent gases back through soil pipe and out roof vents. Improperly installed roof vents can cause odour problems. Traps in drains prevent odours from entering the home. To function they must contain water and be sealed correctly

Odour Locations	Cause	Solution
<b>Strong effluent odour directly outside the house or inside the house</b>	Pipe connections to toilets/drains not connected correctly	Check that the traps/U - bends in the drains are fitted and the joints sealed.
	Air vent on pipe work not installed correctly.	Ensure all effluent pipes are vented correctly. Vents are normally fitted to all pipes and they should be higher than the eave of the roof.
	Pipe work is damaged, blocked or not installed correctly	Inspect pipe work to ensure it is undamaged and clear of obstructions or sagging.
	Septic tank effluent filter blocked (located at septic tank outlet).	Clean filter with hose.
<b>Strong effluent odour directly over the system</b>	Pipe work to or from the septic tank is blocked.	Check the level of wastewater in the tank. Ensure the pipes are not blocked and are installed correctly to the tank.
	Chemical kill of bacteria.	Empty the tanks and fill with fresh water
	No oxygen entering the tank.	Clear any blockages in the vents
	Too much grease entering the plant.	Install/empty grease trap.
	Coconut fibre level/quantity inside the modules are low.	Arrange a replacement of the Coconut fibre.

In accordance with our normal policy of product development, this specification is subject to change without notice.

# 11. Certification

## 11.1. Tricel Puraflo with Tricel Fortis



### Declaration of Performance



**Certificate Number:** DOPO6CPRIRL05202205  
**Product Classification:** Small wastewater treatment system for up to 50PT – Packaged and/or Site Assembled Domestic Wastewater Treatment Plant as set out in EN12566 Part3  
**Name of Product:** Tricel Puraflo with Tricel Fortis

**Product Characteristics:**

Material	Puraflo - Polyethylene (PE) Fortis - Glass Reinforced Plastic (GRP)
Technology	Septic tank with Coconut Fibre filtration
Components	Septic tank, Pump chamber, Coconut Fibre modules, Alarm

**Intended for Use:** To treat domestic wastewater for up to 50 population equivalents

**Manufacturer:** Tricel (Killarney) Unlimited Company trading as Tricel  
 Ballyspillane Ind. Est.  
 Killarney, Co. Kerry  
 +353 (0) 64 6632421  
[www.tricel.ie](http://www.tricel.ie)

**Plant of Assessment of Verification as set out by the CPR, Annex V:** System 3

**Tested By:**

PIA - Prüfinstitut für Abwassertechnik GmbH  
 Hergenrather Weg 30  
 D-52074 Aachen, Germany  
 NB 1739

**Declared Performance:**

**Treatment Performance**

Essential Characteristics	Performance	Harmonised Technical Specification
Nominal Organic Design Load	0.42 kg BOD <sub>5</sub> /d	
Nominal Hydraulic Daily Design Load	1.20 m <sup>3</sup> /d	
COD	93.4% 54 mg/l	EN12566-3
BOD <sub>5</sub>	96.9% 11mg/l	
SS	97.7% 8mg/l	
NH <sub>4</sub> *	85.5% 5.6mg/l	
Electrical Power Consumption	0.1kWh/d	
Number of desludging	0	

\*Determined at temperatures  $\geq 12^{\circ}\text{C}$

**Material Performance:**

Essential Characteristics	Method	Performance	Harmonised Technical Specification
Water Tightness	Fortis-Vacuum Test Puraflo-Water Test	Pass	EN12566-3
Crushing Resistance	Fortis- Pit Test Puraflo- Crush Test	Pass (wet conditions) Pass	
Durability		Pass	

The performance of the product identified is in conformity with the declared performance.

This declaration of performance is issued under the sole responsibility of the manufacturer identified.

Signed for and on behalf of the manufacturer by:

James Butler (Head Of Division)

*James Butler*  
 (signature)

11/05/2022

Date



Tricel Limited Ballyspillane Ind Est  
Killarney Co. Kerry Ireland

22

DOP06CPRIRL05202205

**EN 12566-3**

Packaged Wastewater Treatment Plants for treatment of domestic wastewater

**Product:** Tricel Puraflo with Fortis Wastewater Treatment Plants

**Material:** GRP and PE

**Notified Body:** PIA - Prüfinstitut für Abwassertechnik GmbH  
Hergenrather Weg 30  
D-52074 Aachen, Germany

**Number:** NB 1739

**Treatment Design Capacity:**

Nominal organic daily load: (BOD<sub>5</sub>)  
Nominal Hydraulic daily flow (QN)

As Set Out in Table  
CE  
for each Model

**Effectiveness of Treatment:**

Treatment efficiency ratios (at tested organic daily load  
BOD<sub>5</sub> of 0,42 kg/d and daily hydraulic flow of 1.2m<sup>3</sup>/d)

COD: 93.4%  
BOD<sub>5</sub>: 96.9 %  
SS: 97.7 %  
NH<sub>4</sub>-N: 85.5 %

**Water tightness: (Vacuum test)**

Pass

**Crushing resistance: (Pit test)**

Pass (Fortis: Wet  
Puraflo: Dry)

**Durability**

Pass

**Fire Resistance**

Class E

## 11.2. Tricel Puraflo with Tricel Vento

**Certificate Number:** DOP07CPRIRL05202206  
**Product Classification:** Small wastewater treatment system for up to 50PT – Packaged and/or Site Assembled Domestic Wastewater Treatment Plant as set out in EN12566 Part3  
**Name of Product:** Tricel Puraflo with Tricel Vento

**Product Characteristics:**

Material	Puraflo - Polyethylene (PE)
Technology	Septic tank with Coconut Fibre filtration
Components	Septic tank, Pump Chamber, Coconut Fibre modules, Alarm

**Intended for Use:** To treat domestic wastewater for up to 50 population equivalents

**Manufacturer:** Tricel (Killarney) Unlimited Company trading as Tricel  
 Ballyspillane Ind. Est.  
 Killarney, Co. Kerry  
 +353 (0) 64 6632421  
[www.tricel.ie](http://www.tricel.ie)

**Plant of Assessment of Verification as set out by the CPR, Annex V:** System 3

**Tested By:**

PIA - Prüfinstitut für Abwassertechnik GmbH Hergenrather Weg 30 D-52074 Aachen, Germany NB 1739	Centre d'Etudes et de Recherche de l'Industrie du Béton (CERIB) 1, rue des Longs Réages – B.P. 30059 28231 Epernon Cedex France NB 1164
--	--

**Declared Performance:**

**Treatment Performance**

Essential Characteristics	Performance	Harmonised Technical Specification
Nominal Organic Design Load	0.42 kg BODs/d	EN12566-3
Nominal Hydraulic Daly Design Load	1.20 m <sup>3</sup> /d	
COD	93.4% 54 mg/l	
BOD <sub>5</sub>	96.9% 11mg/l	
SS	97.7% 8mg/l	
NH <sub>4</sub> *	85.5% 5.6mg/l	
Electrical Power Consumption	0.1kWh/d	
Number of desludging	0	

\*Determined at temperatures  $\geq 12^{\circ}\text{C}$

**Material Performance:**

Essential Characteristics	Method	Performance	Harmonised Technical Specification
Water Tightness		Pass	EN12566-3
Crushing Resistance	Vento Puraflo- Crush Test	Pass (wet conditions) Pass	
Durability		Pass	

The performance of the product identified is in conformity with the declared performance.

This declaration of performance is issued under the sole responsibility of the manufacturer identified.

Signed for and on behalf of the manufacturer by:

James Butler (Head Of Division)

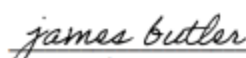
  
 (signature)

11/05/2022

Date





Tricel Limited Ballyspillane Ind Est  
Killarney Co. Kerry Ireland

22

DOP07CPRIRL05202206

EN 12566-3

Packaged Wastewater Treatment Plants for treatment of domestic wastewater

**Product:** Tricel Puraflo with Vento Wastewater Treatment Plants  
**Material:** PE

<b>Notified Body:</b>	CERIB 1, rue des Longs Reges - B.P. 30059 28231 Epernon Cedex France
<b>Number:</b>	NB 1164
<b>Notified Body:</b>	PIA - Prüfinstitut für Abwassertechnik GmbH Hergenrather Weg 30 D-52074 Aachen, Germany
<b>Number:</b>	NB 1739
<b>Treatment Design Capacity:</b>	
Nominal organic daily load: (BOD <sub>5</sub> ) Nominal Hydraulic daily flow (QN)	As Set Out in Table CE for each Model
<b>Effectiveness of Treatment:</b>	
Treatment efficiency ratios (at tested organic daily load BOD <sub>5</sub> of 0,42 kg/d and daily hydraulic flow of 1.2m <sup>3</sup> /d)	COD: 93.4% BOD <sub>5</sub> : 96.9 % SS: 97.7 % NH4-N: 85.5 %
<b>Water tightness: (Vacuum test)</b>	Pass
<b>Crushing resistance: (Pit test)</b>	Pass (Vento: Wet Puraflo: Dry)
<b>Durability</b>	Pass
<b>Fire Resistance</b>	Class E

### 11.3. Tricel Puraflo

Tricel Puraflo Modules tested to EN12566 Part 6, can be used in conjunction with a septic tank tested to EN12566-1 with 98.5% hydraulic efficiency.

<b>Puraflo Secondary</b>	<b>This Unit is a (Tick "X")</b>	<b>Puraflo Tertiary</b>	<b>This Unit is a (Tick "X")</b>
Two Module		Two Module	
Three Module		Three Module	
Four Module		Four Module	
Six Module		Six Module	
Eight Module		Eight Module	
Ten Module		Ten Module	
Twelve Module		Twelve Module	

This page is blank

This page is blank



Tricel (Killarney) Unlimited Company Trading as Tricel  
Ballyspillane Ind. Est. Killarney, Co. Kerry, Ireland

Tel: +353 (0)64 663 2421 | Email: [sales@tricel.ie](mailto:sales@tricel.ie) | [www.tricel.ie](http://www.tricel.ie)

Tricel Environmental UK, A trading brand of Dewey Waters Ltd.  
Tricel Weston, Winterstoke Road, Weston-Super-Mare, BS24 9AN, United Kingdom

Tel: 44 (0) 1934 422 311 | Email: [environment@tricel.co.uk](mailto:environment@tricel.co.uk) | [www.tricel.co.uk](http://www.tricel.co.uk)

In accordance with Tricel's normal policy of product development these specifications are subject to change without notice.